

ProSYS Plus
One Platform. All Applications
Taking Commercial Security to the Limit



Advanced Communications
Backup & Redundancy

Super Hybrid
Commercial & Industrial Detectors

High Security
Grade 3

RISCO Cloud
Value Added Services

End-to-End
Commercial
Solutions

Ultimate Scalability
up to 512 Zones

Variety of
Monitoring &
Control Solutions

System
Highlights

Value
Proposition

End

ProSYS Plus

Taking Security to the Limit

Unlimited Scalability | Innovative Licensing



The Ultimate
Single-Platform
Solution

All Installations

All Applications

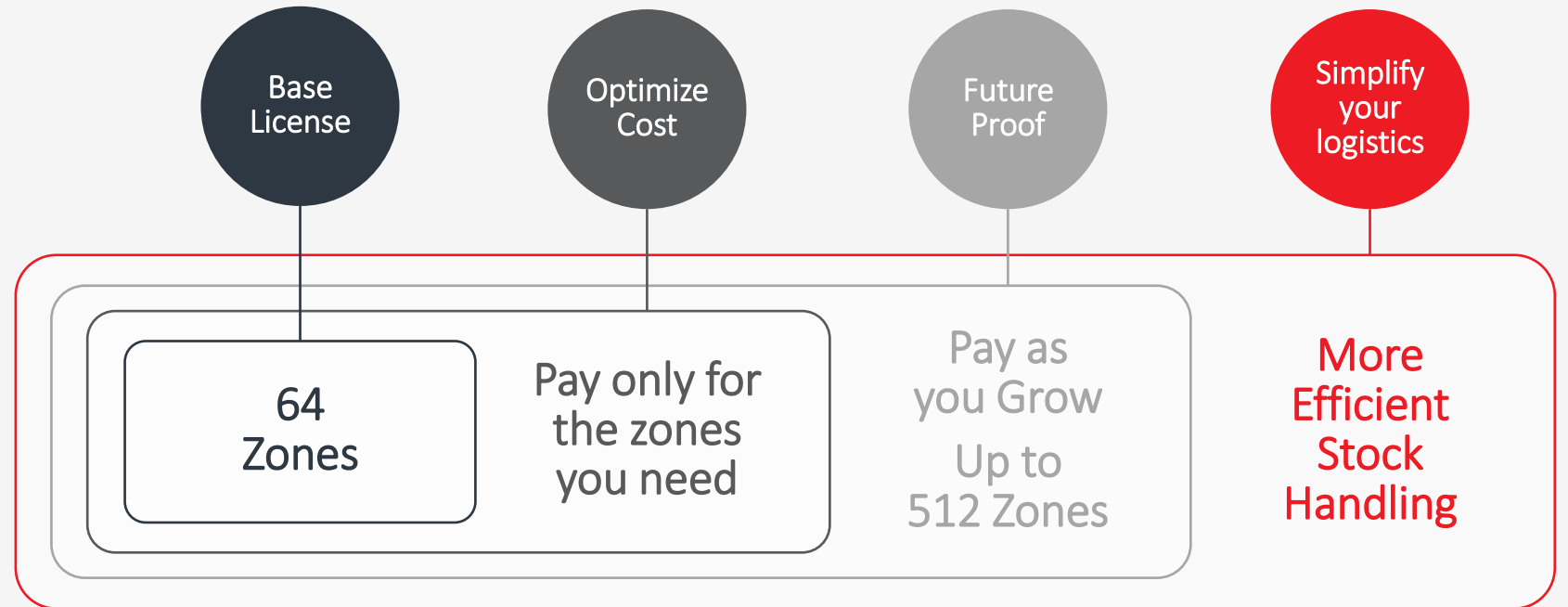

High-end Residential

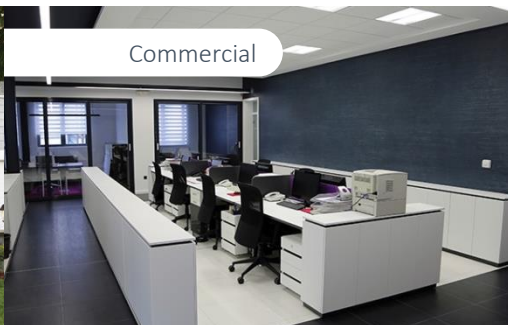

Commercial



Logistic



Critical Infrastructure

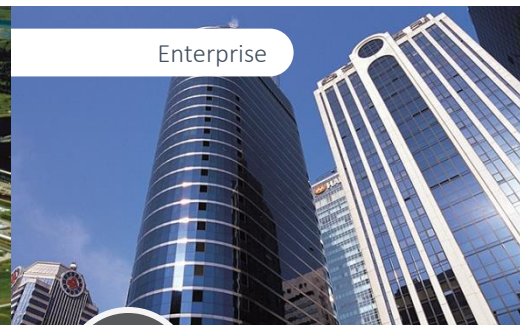

Enterprise





Commercial Indoor Detectors

Wired, wireless & Bus
Superior catch performance
Uniform look across the site



Commercial Ceiling Detectors

Compact and sleek
PIR, DT & DT AM Versions
Grade 2 and Grade 3



Outdoor Detectors

Harsh outdoor environment
Unique detection algorithms
Superior visual verification



Industrial Ceiling Detectors

8.6m installation height
Wide coverage radius
Infrastructure cost saving



Heavy Duty Seismic Detectors

High Security protection
Safes, Vaults & ATMs
Keyhole Protection Option



Industrial Grade Detectors

Harsh indoor environment
False alarm mitigation
Long range – 25m

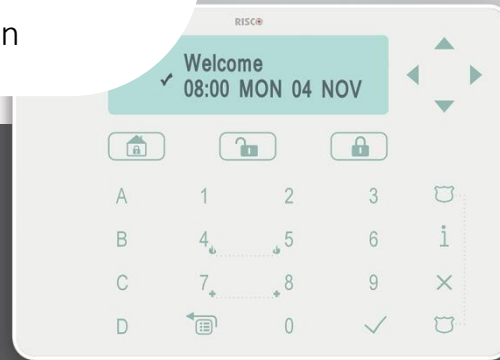

Grade 3 | End-to-End High Security



Advanced Communications

Multi-Socket. Backup & Redundancy

Advanced Multi-Socket Communications

3G Cellular Connectivity

Automatic backup (failover) between IP & 2G/3G

Automatic cloud backup for alarm reporting to CMS

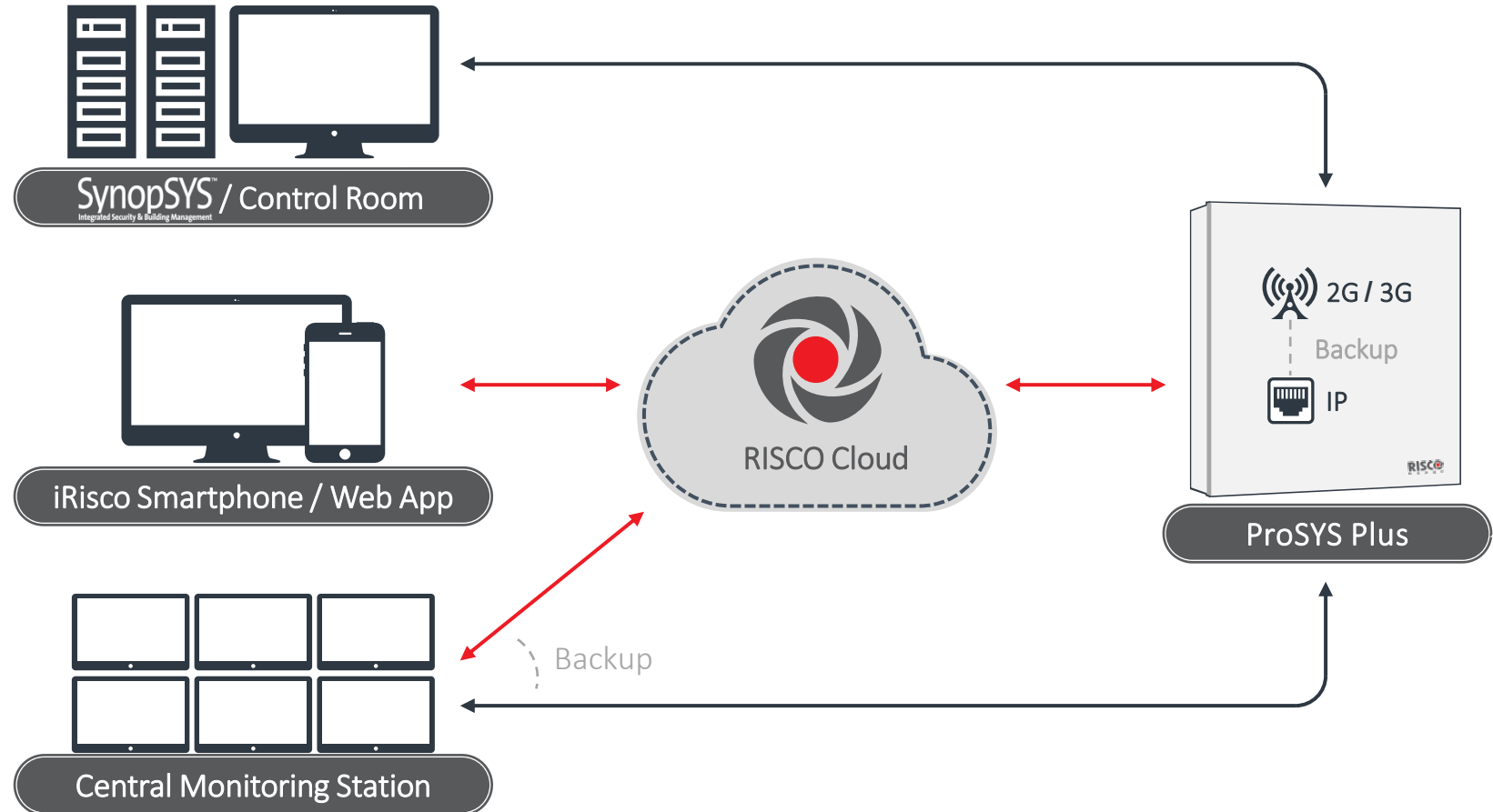

Super Hybrid

Remote Diagnostics & Configuration. Save time & money.

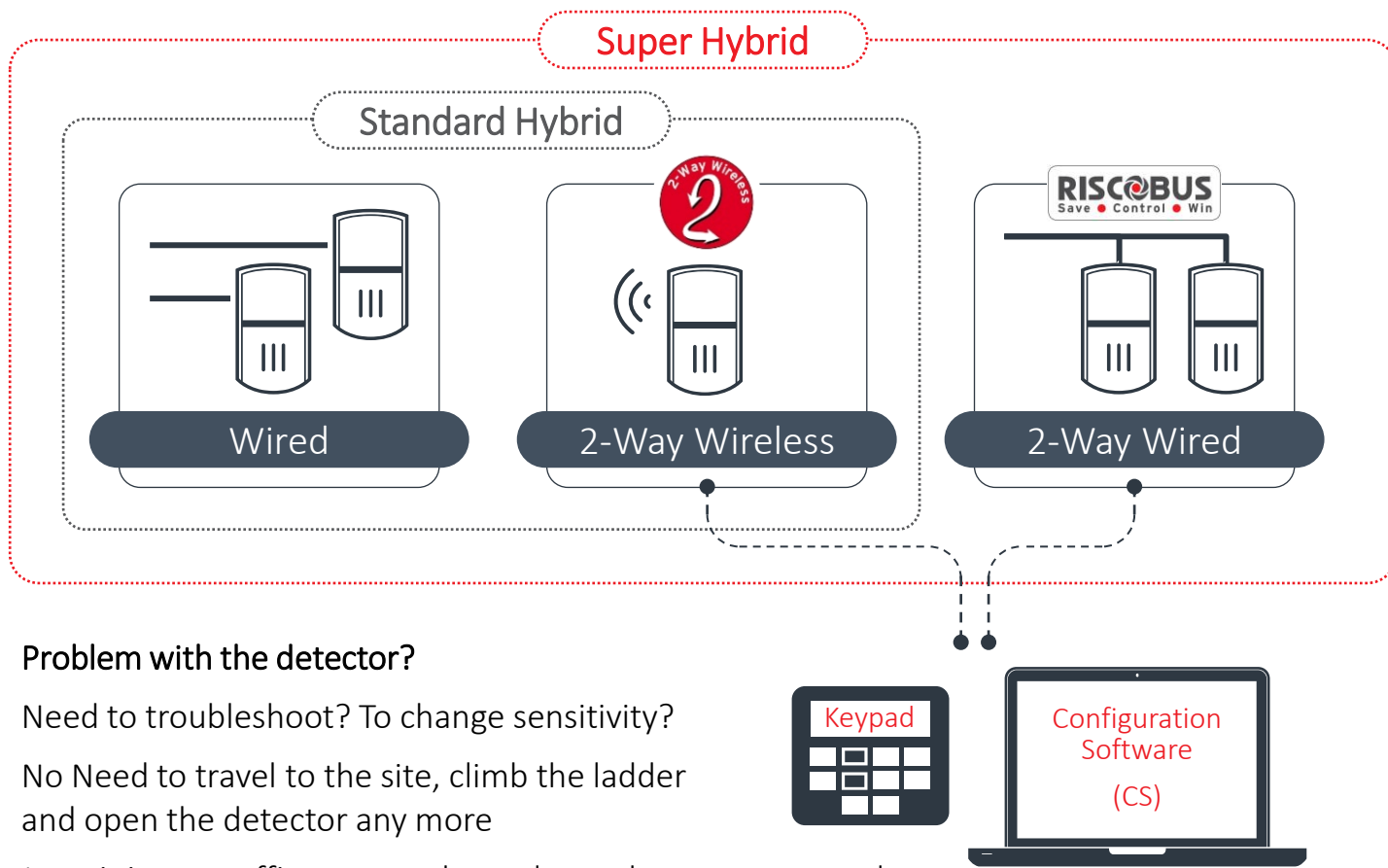

Problem with the detector?

Need to troubleshoot? To change sensitivity?

No Need to travel to the site, climb the ladder and open the detector any more

Just sit in your office or anywhere else and connect remotely.

Remote Diagnostic & Configuration
Control all parameters remotely



Diagnostics

Supply Voltage

PIR & Microwave
Level

PIR &
Microwave
Noise

Anti-Mask Level

Temperature
Level (Seismic)



Configuration

Sensitivity
Settings

Self Test

Anti Mask
On/Off

Anti-Cloak™
On/OFF

LED On/Off



RISCO Addressable Bus Detectors

Topology Options

Total Flexibility

Full Diagnostics
& Control

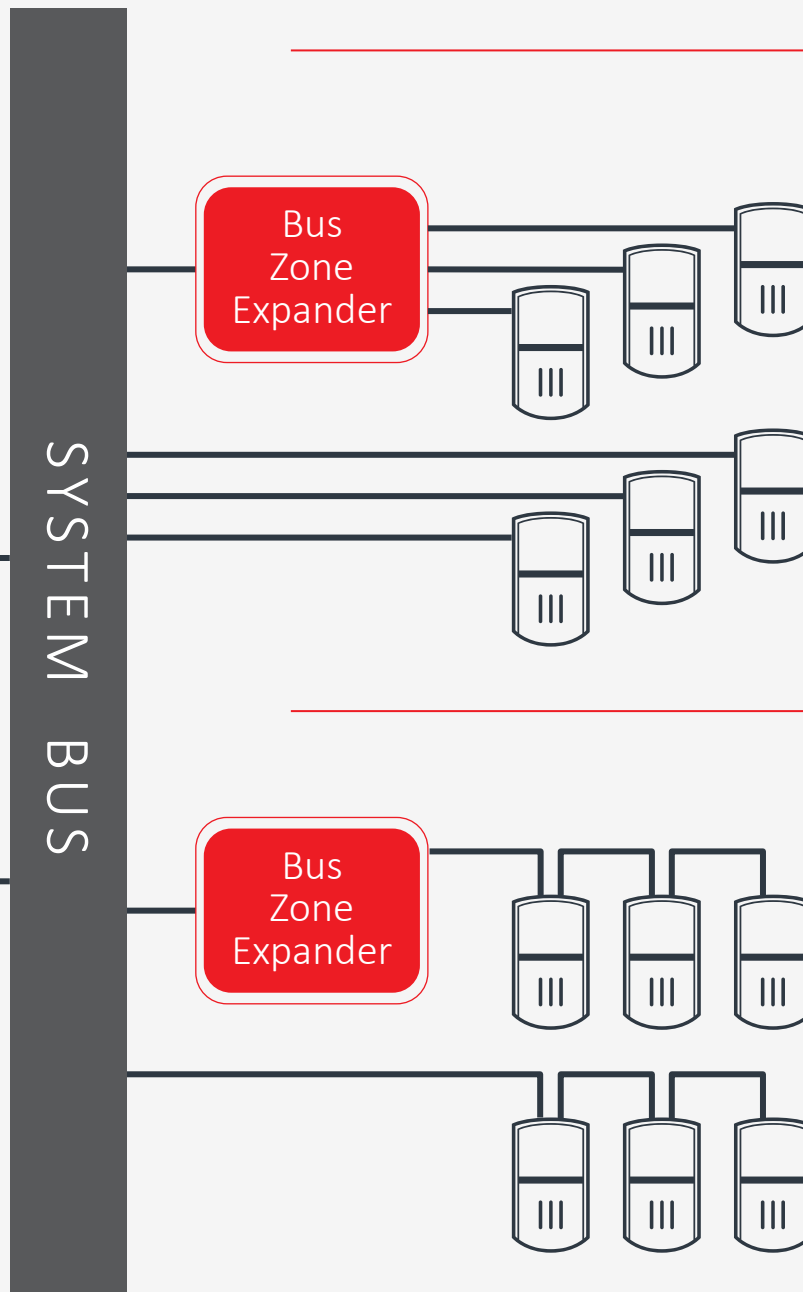

Standard "Star" Wiring Future Proof

BUS Zone Expander

- 32 Detectors Per Expander
- 512 Detectors per system

Detectors on System Bus

- Up to 100 Bus Detectors per system
- Saving zone expanders

Daisy-Chain "Bus" Wiring Huge Cable Saving

BUS Zone Expander

- 32 Bus Detectors per expander
- 512 Detectors per system

Detectors on System Bus

- Up to 100 Bus Detectors per system
- Saving zone expanders



RISCO Cloud

Value Added Services. Remote Monitoring & maintenance.

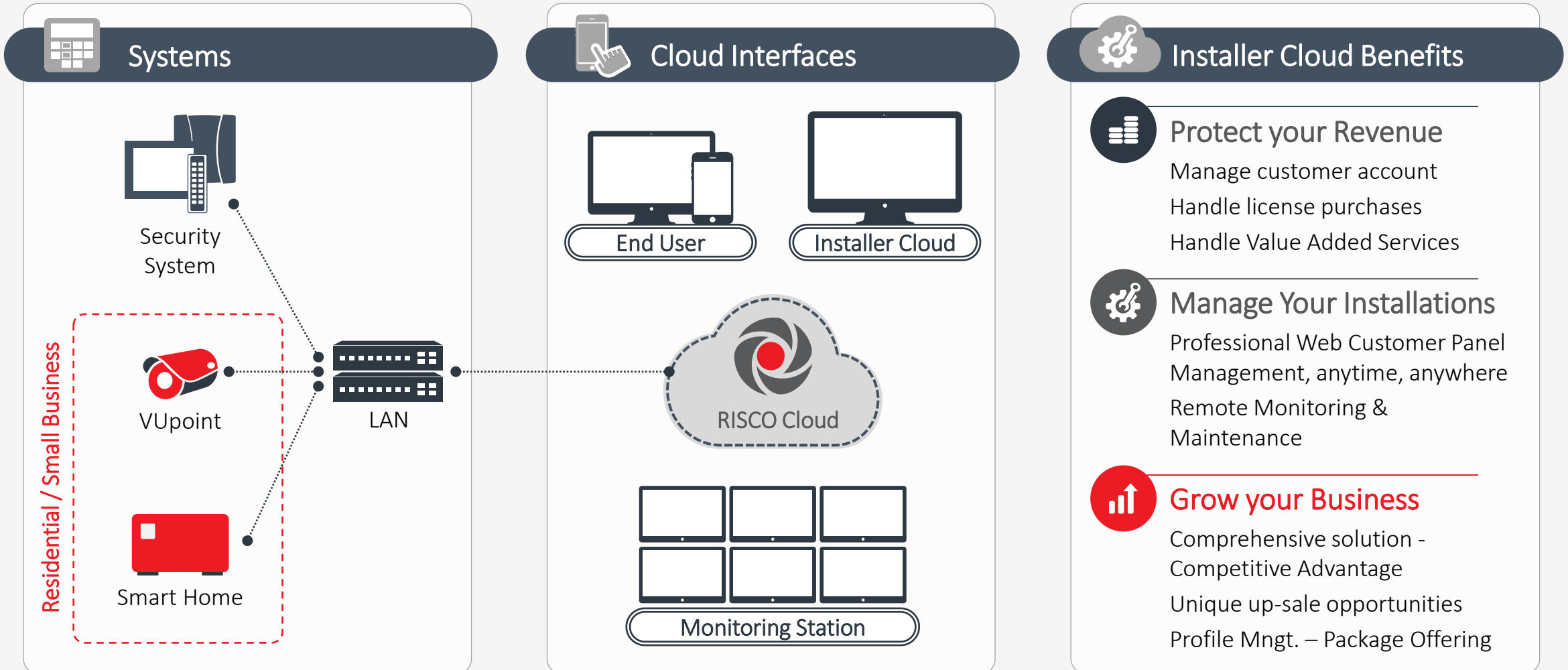

Variety of Monitoring & Control Solutions



High End
Residential



ProSYS™ Plus

iRISCO



Central Monitoring Station



SynopSYS™
Integrated Security & Building Management



Control Room



Commercial
& Enterprise



ProSYS Plus | Specification Highlights



ProSYS Plus	ProSYS 128	LightSYS
512 zones	(128)	(50)
32 Partitions	(8)	(4)
500 User Codes	(99)	(30)
2-Way Wireless	(-)	(+)
Multi-Socket IP Module	(-)	(+)
2G & 3G Cellular Modules	(2G)	(2G&3G)
4 System Bus Lines	(1)	(1)
48 Wired Keypads	(16)	(4)
Selectable Zone Resistance	(-)	(+)
2000 Events Log	(999)	(1000)
6-262 Programmable Outputs	(6-70)	(4-32)



4 Independent Bus Lines

More Devices.
More Redundancy.

More Devices

- 1 Bus – up to 32 devices
- 4 Buses – up to 128 devices

More Redundancy / Resilience

Failure on one Bus – $\frac{3}{4}$ of the system still fully functional

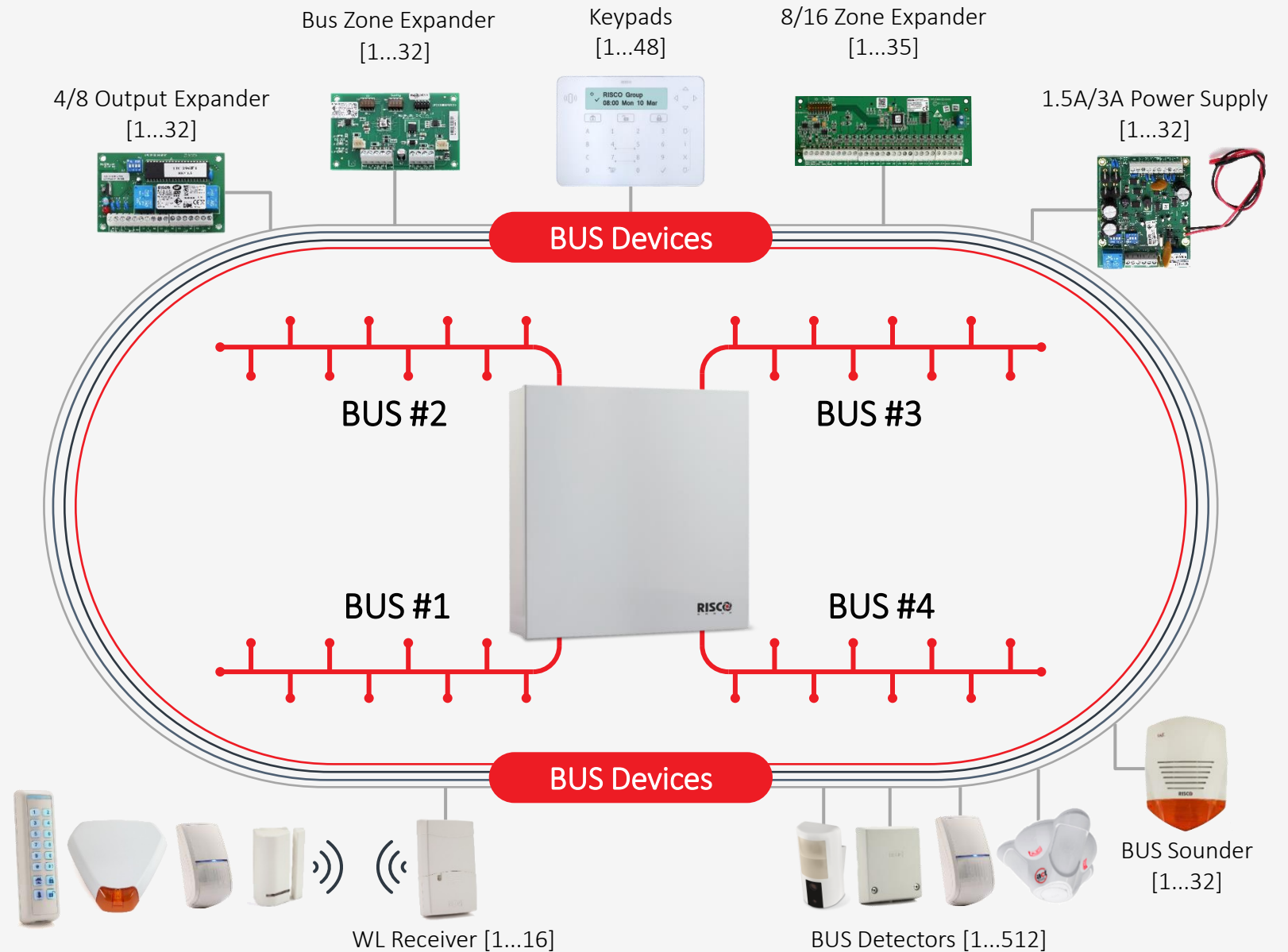

Commercial Offering | End-to-End Solution

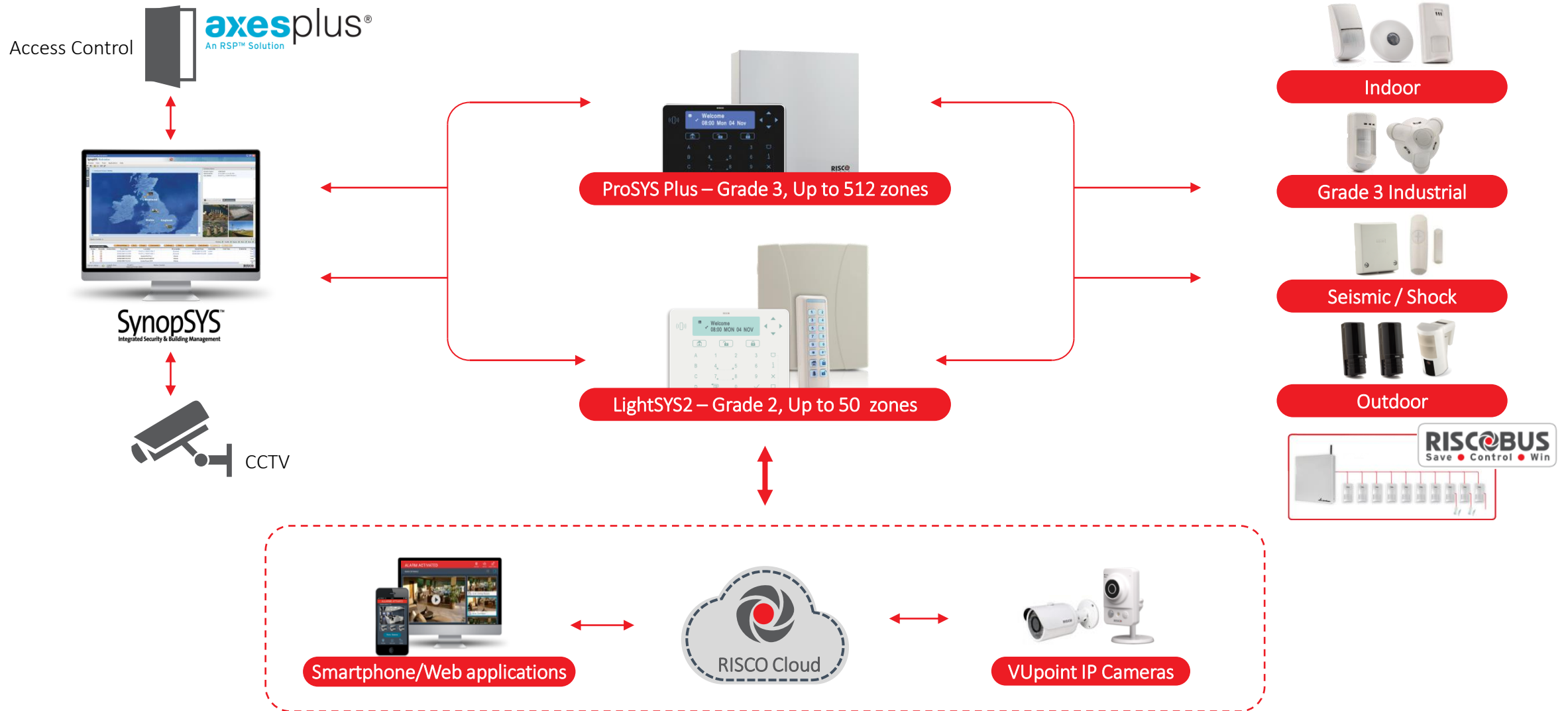

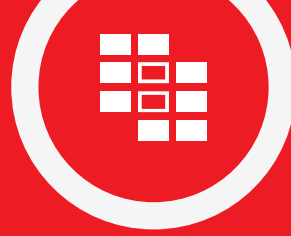

• Expert security solutions

Every type of industry | Every type of Application

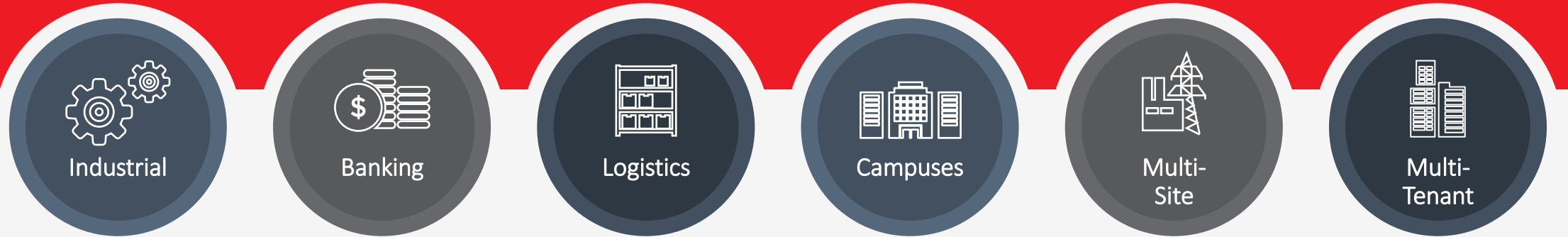

1

Field proven experience in high security commercial projects

2

End to End professional Intrusion solution portfolio

3

SynopSYS PSIM
Ideal for Multi-Site System Architecture

4

API for Integration with 3rd party PSIM



Industrial Facilities

Unique Harsh-Environment Detection Technologies



Benefits

Large No. of partitions (32):

- Round the clock operation with multiple departments
- Single keypad for the guard

Central management:

- SynopSYS Central Management System for Control Rooms
- Optional RISCO Cloud web management / Smartphone app for security officers

Professional, Specialized Grade-3 Detectors:

- WatchIN – Robust Industrial detector (IP65) with unique algorithms for harsh environments
- Industril Lunar – High Ceiling Detector with wide coverage



Banking Sector

Holistic Solution. One Stop Shop.



Benefits



HQ



ProSYS Plus



G3 Detectors



SynopSYS
Integrated Security & Building Management



Branch



ProSYS Plus



G3 Detectors



ATM



LightSYS / ProSYS Plus



Seismic / Shock Detectors

Large number of partitions:

HQ – Many Departments

Branch – Secured Areas

Single Keypad for the Guard

SynopSYS Central Management System:

- Central Command & Control
- Client-Server for Regional Monitoring

Full Detector Range



Logistic Centers

Specialized Solution. Unique Detection Technologies.



Benefits

32 partitions:

- Round the clock operation with multiple departments
- Single keypad for the guard

Central management

- SynopSYS Central Management System for Control Rooms
- Optional RISCO Cloud web management Interface
- Smartphone app for security officers

Cost Effective, High Security solution using Unique high ceiling detectors



Ideal For Shelved Storage
Covering Huge Spaces with a few detectors



Campus Security

Complete Solution with Central Management



Benefits



Universities



Hospitals

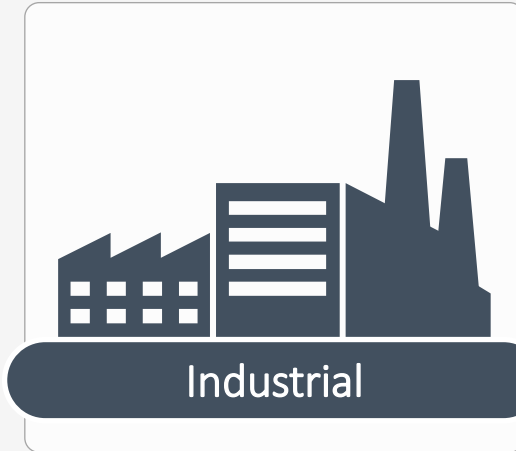

Industrial

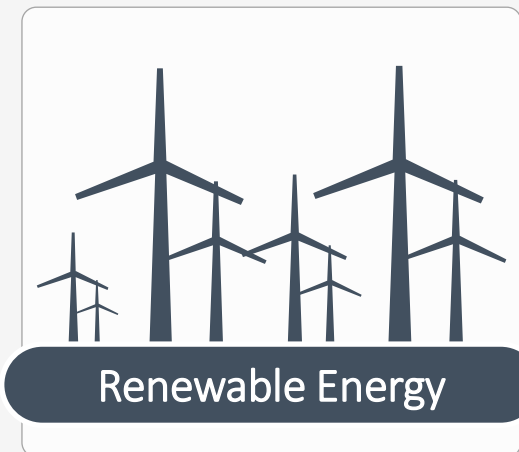

Renewable Energy



Critical Infrastructure



Military

Large number of partitions:

- Small to medium campuses can be covered by 1 panel
- Single keypad for the guard in the control room

Advanced IP communication for multi-panel installations

SynopSYS Central Management System for Control Rooms

Optional RISCO Cloud online management Interface for single panel installations

- Web interface for the guard
- Smartphone app for security officers



Multi-Site architecture

National monitoring, Regional control.



Benefits

Versatile, Cost Effective solution:

- Single Panel for small and large sites
- Variety of communication options – IP/2G/3G

Account Per partition

- Each partition can report to a different MS

Central management

- SynopSYS Client/Server application for hierarchy-based / regional Command & Control

Unique outdoor and perimeter detectors for complete site security

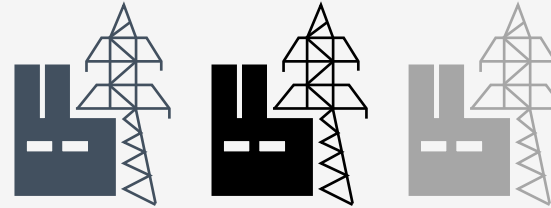
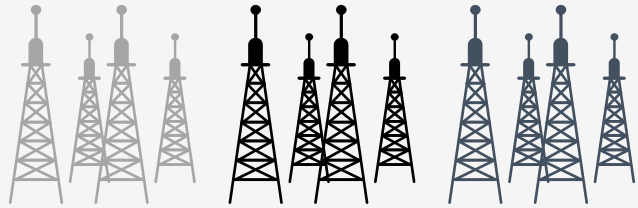

Regional Control Room



Regional Control Room



HQ



Multi Tenant Deployments

Cost Effective, Comprehensive Solution



Office Building

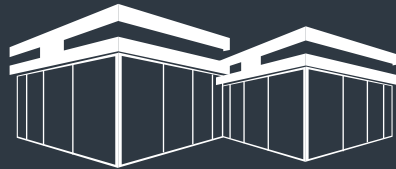

Shopping Centers



Apartment Buildings / Gated Communities



Benefits

Large number of partitions (up to 32 tenants per panel)

Single Keypad for the Guard

SynopSYS Central Management System for Control Rooms

RISCO Cloud online management Interface on partition level

- Web interface for the guard
- Smartphone app for each tenant

Vupoint Cameras Integration

MS Account Per Partition



The Value proposition Installer & Integrator

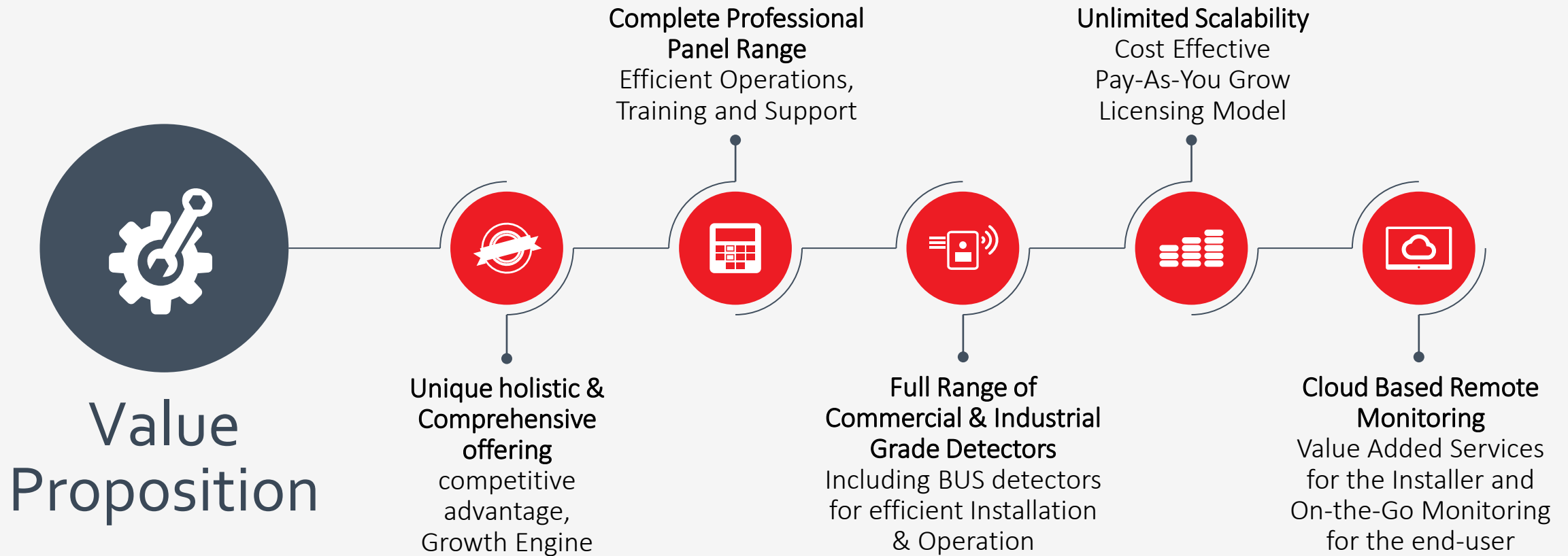

All Your Installations. All Your Applications. Easier Operations.



Thank You

